



## 箱型交流金属封闭环网开关设备 AC Metal-enclosed Ring Main Unit Switchgear

# XGN15-12F



天仑电气 - 为您提供一流的电力系统解决方案  
Tianlun Electric, provide you with first-class power system solution

宁波天仑电气有限公司  
NINGBO TIANLUN ELECTRIC CO., LTD

宁波市北仑区江南中路 10 号  
No. 10, jiangnan Road, Beilun, Ningbo, China  
传真 (Fax): +86-0574-8619 3383 网址 (Web): www.cn-tianlun.com

联系电话 (TEL)  
**86-574-8619 3396 (中国)**  
**86-574-8619 3389 (International)**



企业官网  
Website qr code



微信公众号  
Wechat qr code

本型录文字、参数规格及资讯仅供参考。产品以实物为准，内容亦会随时更新。本公司样本及商标版权所有，翻录必究。型录所有机型为我司专利产品，仿冒必究。  
The text, specifications and information of catalogue are for only reference. Products depend on the actual model, the content will be updated without notice. The company sample and trademark copyright reserved, and counterfeiting is not allowed. all the models for our patented products, copying is not permitted.

宁波天仑电气有限公司  
NINGBO TIANLUN ELECTRIC CO., LTD



## 公司简介 Introduction

宁波天仑电气有限公司(以下简称公司)成立于2001年1月。

公司坐落于浙江宁波,毗邻“东方大港”北仑港。拥有10000平方米的研发生产基地,年产值超亿元,目前有80多名年轻朝气的员工,其中60%为本科学历。公司是集研发、生产、销售、服务于一体的高新技术企业,致力于打造高品质的智能化、节能型、定制模式的输变电设备产品。

公司目前有符合国际及国内标准3大类18种产品,包括24kV中置式开关柜及环网柜,12kV中置式开关柜及环网柜,440V固定式分隔柜,抽屉式开关柜,预装式变电站,低压母线槽(合作生产),10kV变压器(合作生产)等等,同时部分为ABB、Schneider的授权产品。公司立足于浙江,为很多大型的制造企业、房产开发、学校、港口等用户提供了许多高质量的产品和服务,同时也出口到东非、北非及东南亚国家,获得了客户的一致满意。

公司严格执行ISO9001质量保证体系,标准化体系,安全生产标准体系,国家CCC认证体系。坚持持续提升产品质量,追求零缺陷产品,全心全意服务用户的质量方针,坚持以人为本,鼓励创新,精细化的管理理念,坚持以感恩在心为核心价值观,为我们的用户提供最好的产品和服务。

Ningbo TIANLUN Electric Co., Ltd was established in year 2001, January. It is located in Ningbo, near Beilun port, which is called "oriental grand port". TIANLUN has 10000-square-meter researching and developing workshop and annual output value exceeds 100 million. TIANLUN has a professional team composed of 80 innovative staff, most of them have bachelor's degrees. TIANLUN is a company that integrates researching, developing, selling and service. Our purpose is to create high quality electric equipment product which is intelligentized, energy-saving and customized.

TIANLUN mainly have 18 types of products which belong to 3 majors as follow: 24 kV Intermediate switchgear and Ring Main Unit Switchgear, 12kV Intermediate Switchgear and Ring Main Unit Switchgear, 440V Fixed Isolated Switchgear, Preparatory Transformer Substation, Low Voltage Bus Duct (coproduction) and 10kV transformer (coproduction). Some products are Licensed by ABB and Schneider. TIANLUN have been providing high quality products to large manufacture enterprise, real estate, school and port constructions. At the mean time, our product are exported to Africa and southeastern countries and win satisfaction from the overseas customers.

TIANLUN strictly stick to ISO9001 standard system, standardization system, safety standard system and CCC authentication system. Our quality policy is producing good and zero defect product, having customers well served. Our management policy is people orientation, creation encouragement and high-effective system. TIANLUN always hold a thankful heart and provide top-level product with best service.

## 产品概述

### Overview

XGN15-12F 箱型交流金属封闭环网开关设备(以下简称环网柜),是我厂吸收国内外先进技术,自行设计、研制的新产品,该产品技术性能指标达到 IEC62271《高压开关设备和控制设备》和 GB3906《3.6kV~40.5kV 交流金属封闭开关设备和控制设备》。由于产品具有体积小、重量轻、操作灵活、维护方便、质量稳定可靠、并具备完善的“五防”联锁功能,防护等级达到 IP2X 等优点,是城市电网改造的理想配套产品,主要适用于 50Hz 的三相交流网络中,作为电能的接受和分配之用。

The XGN15-12F AC Metal-enclosed Ring Main Unit Switchgear (hereinafter referred to as "ring main unit") is a new product designed and developed by Tianlun Electric by introducing overseas advanced techniques. The technical indicators of the product reaches IEC62271 High-voltage Switchgear&Controlgear and GB3906 3.6kV~40.5kV AC Metal Ring Switchgear and Controlgear. The product is characterized by small volume, light weight, operation flexibility, maintenance convenience, and quality stability & reliability, and it comes out with perfect interlock protection functions and IP2X protection grade, so it is an ideal product for mains grid reconstruction. The product is mainly applicable to 50Hz three-phase AC network for receiving and distributing energy.

## 型号含义

### Model Description

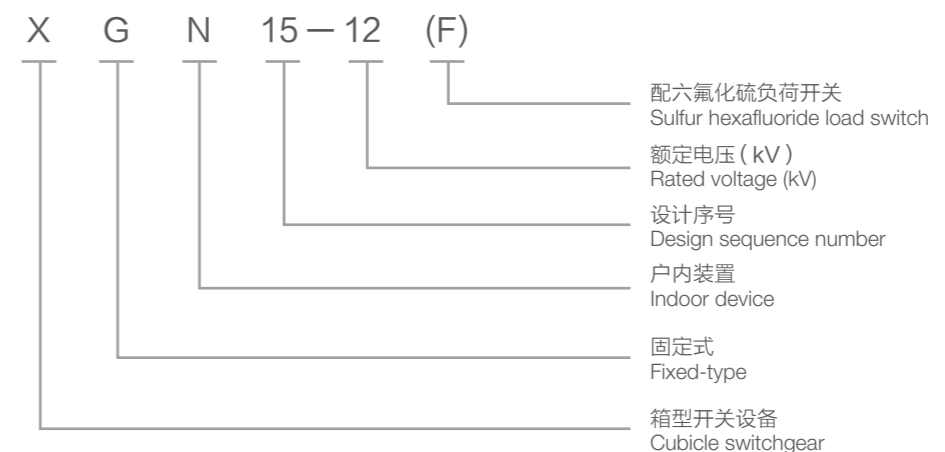

## 使用环境

### Environmental Requirements

- 环境温度: 不高于 +40°C, 不低于 -25°C;
- 海拔高度: 不超过 1000m;
- 相对湿度: 日平均值不大于 95%, 月平均值不大于 90%;
- 适用场所: 没有火灾、爆炸危险、严重污秽、化学腐蚀及剧烈振动的场所。

- Ambient temperature: -25°C ~ +40°C
- Altitude ≤ 1000m
- Relative humidity: daily relative humidity ≤ 95% on average; monthly relative humidity ≤ 90% on average
- Applicable scenario: places that are free of risk of fire and explosion, severe dirt, and chemical corrosives and places that will not cause violent vibration.



ISO9001-2000



CCC 认证



WSC 北京世标认证中心



## 技术参数

### Technical Data

环网柜的主要技术参数见表 1。

Table 1 lists the main technical indicators of the ring main unit.

序号 Sn	名称 Name	单位 Unit	技术参数 Technical Data
1	额定电压 /Rated voltage	kV	12
2	额定频率 /Rated frequency	Hz	50
3	主母线额定电流 /Rated current of main bus	A	630
4	主回路、接地回路额定短时耐受电流 Rated short-time withstand current of main circuit and grounding circuit	kA/s	20/2
5	主回路、接地回路额定峰值耐受电流 Rated peak withstand current of main circuit and grounding circuit	kA	50
6	主回路、接地回路额定短路关合电流 Rated short-circuit making current of main circuit and grounding circuit	kA	50
7	负荷开关满容量开断次数 /Load switch full-capacity breaking times	次 /Times	100
8	熔断器开断电流 /Fuse breaking current	kA	31.5
9	1min 工频耐受电压 (有效值) 相间、对地 / 隔离断口 1min power frequency withstand voltage (valid value) between phases, to ground, to isolating fracture	kV	42/48
10	雷电冲击耐受电压 (峰值) 相间、对地 / 隔离断口 Impulse withstand voltage (peak value) between phases, to ground, to isolating fracture	kV	75/85
11	二次回路 1min 工频耐压 /1min power frequency withstand voltage of secondary circuit	kV	2
12	防护等级 /Degrees of protection		IP2X

环网柜选用 ABB 公司专业制造的 SFL-12 型 SF6 负荷开关，其性能参数见下表。

Adopt the SFL-12 type SF6 load switch for the ring main unit. The following table lists the technical indicators of the load switch.

序号 Sn	名称 Name	单位 Unit	技术参数 Technical Data
1	额定电压 /Rated voltage	kV	12
2	额定雷电冲击耐受电压 (相间及对地 / 断口间) Rated impulse withstand voltage (between phases, to ground, to fracture)	kV	95/110
3	额定短时工频耐受电压 50Hz, 1min (相间及对地 / 断口间) Rated short-time power frequency withstand voltage 50 Hz, 1min (between phases, to ground, to fracture)	kV	42/48
4	额定电流 /Rated current	A	630
5	2s 额定短时耐受电流 /2s rated short-time withstand current	kA	25
6	额定峰值耐受电流 /Rated peak withstand current	kA	63
7	额定短路关合电流 /Rated short-circuit making current	kA	63
8	环境温度 /Ambient temperature	℃	-40 至 +40
9	额定转移电流 (SFL-F)/Rated transfer current (SFL-F)	A	1700
10	熔断器最大额定电流 (SFL-F) /Max. rated current of fuse (SFL-F)	A	125
11	相间距 (中心距) /Clearance between poles (central distance)	mm	210
12	机械寿命 /Service life	次 /Times	5000

## 结构概述

### Structure

- 环网柜由外壳、负荷开关、接地开关、仪表室、母线及其它电器元件和辅助元件组成，柜后设有压力释放口。内部由操作机构箱、母线室、电缆室三个相互独立的隔室组成，SFL-12 型 SF6 负荷开关安装在母线室与电缆室之间的隔板上，这种安装方式保证了上部的母线与下部的电缆之间的隔离。外壳和各功能单元的隔板均采用优质钢板冲压而成，柜体采用螺栓连接。
- 环网柜三相排列按纵向结构布置，柜体之间的三相母线连接较为方便。
- 仪表室位于环网柜的上部，室内可装设电流表、电压表、转换开关、指示灯等元件，在仪表室底部可装设二次回路的端子排等。
- 在仪表室右上方可装设电动分合闸机构，可用于远程控制。

- The ring main unit is composed of enclosure, load breaking switch, grounding switch, instrument cubicle, bus, and other electric elements and auxiliary elements. A pressure relief outlet is set at the back of the cabinet. The internal part of the cabinet is divided into three independent cubicles; they are operation mechanism case, bus cubicle, and cable cubicle. The SFL-12 type SF6 load breaking switches are installed on the isolating board that is located between the bus cubicle and the cable cubicle. This installation method ensures the isolation of the upper bus from the lower cable. The isolation boards of the housing and various function units are made of quality steel boards by means of punching and the entire cabinet is fixed using bolts.
- The three phases of the main ring unit are arranged vertically to facilitate inter-cabinet bus connection.
- The instrument cubicle of the main ring unit is located on the upper part of the cabinet and it can accommodate ammeter, voltmeter, conversion switch, indicator, and other elements. At the bottom of the cubicle, terminal bar can be installed for secondary circuit.
- At the right upper part of the instrument cubicle, an electric ON/OFF mechanism can be installed to implement remote control.

其基本结构如图 1 所示。

Figure 1 shows the basic structure of the cabinet.

## 安装与调整

### Installation and Adjustment

- 安装开关柜的地面基础施工应符合“电力建设施工及验收技术规范”中的柜与槽钢连接的规定。环网柜的基础槽钢应高于基础 1 ~ 3mm，如图 3 所示。
- 安装时按环网柜先后顺序排列在地基的槽钢上，将柜体靠紧，并用螺栓固定旋紧，柜面应排列整齐，柜顶与屋顶的距离应大于 600mm。
- 各柜的母线室内装上主母线，并用螺栓固定旋紧，在固定的搭接面上需经表面搪锡处理。
- 环网柜的主接地与配电室的接地线连接，该连接应能承受短路引起的热机械应力，能保证接地回路的连续性。安装完毕后，将开关元件及防误操作机构进行 5 次分、合闸，如未发生异常现象，则认为开关机械操作正常。

- The foundation to install the switchgear shall comply with the prescriptions about cabinet and channel steel connection in the Technical Specifications for Electric Construction and Acceptance. The foundation area to install channel steel shall be 1~3mm higher than the foundation of the switchgear, as show in Figure 3.
- Install the ring main units along the channel steel in accordance with the sequence of the cabinets, make the cabinets as close as possible, and use bolts to fix them. The cabinet surface shall be neat with the cabinet top 600mm at least away from the roof.
- Install main bus in the bus cubicle of the cabinet and use bolts to fix it. The connection joints shall be tinned.
- The connection between the main grounding cable of the ring main unit and the grounding cable of the power distribution cubicle shall be capable of bearing thermal mechanical stress caused by short circuit and guarantee connectivity of the grounding circuit. After the ring main unit is installed, turn on and off the switchgear lements and misoperation prevention mechanism five times. If no anomaly occurs, switchgear operation is considered normal.

## 联锁及操作

### Interlocking and Operation

1. 环网柜具备以下联锁:

1. The ring main unit comes out with the following interlock functions:

- 负荷开关合闸后，接地开关不能动作；
- 接地开关合闸后，负荷开关不能动作；
- 只有当负荷开关分闸，接地开关合闸时，才允许打开环网柜前门，其它情况下门均处于联锁状态；
- 前门打开后，负荷开关不能合闸；
- 当开关柜作为联络柜或电缆进线柜使用时，接地开关与进线电缆之间能实行强制闭锁。

- The load-breaking switch cannot act after the grounding switch is turned on;
- The grounding switch cannot act after the load-breaking switch is turned on;
- The front door of the ring main unit can be opened only after the load-breaking switch is turned off and the grounding switch is turned on, Other condition it is interlocked;
- The load-breaking switch cannot be turned on after the front door is opened;
- When the switchgear is used as a contact cabinet or for cable incoming deployment, the grounding switch is forcibly locked with the incoming cable.

2. 操作

2. Operation

#### 方案一：接地开关的操作（合分操作）

把专用操作手柄插入接地开关操作孔，手柄顺时针转动方向为开关合闸方向；反之为开关分闸方向。

#### Solution 1: Turn on and off the grounding switch

Insert the special operation handle into the hole of the grounding switch and rotate the handle clockwise to turn on the switch; rotate the handle anticlockwise to turn off the switch.

#### 方案二：负荷开关的操作（合分操作）

- 把专用操作手柄插入负荷开关操作孔，对进线柜，手柄顺时针转动方向为开关合闸方向，反之为开关分闸方向；对出线柜手柄顺时针转动方向为开关合闸方向，开关分闸用手动分闸按钮分闸。
- 用电动机机构分合闸。进线柜中用电动机机构分合闸；出线柜中用电动机机构合闸，用分闸线圈分闸。当选用带撞针的熔断器方案时，开关所配的机构具备分闸脱扣功能。此时，当负荷开关在合闸过程中，其分闸弹簧已处于储能状态，当熔断器撞针撞击脱扣机构时，带动操作机构而使开关分闸。

#### Solution 2: Turn on and off the load-breaking switch

- Insert the special operation handle into the hole of the load switch. For a cable incoming cabinet, rotate the handle clockwise to turn on the switch and rotate the handle anticlockwise to turn off the switch; for a cable outgoing cabinet, rotate the handle clockwise to turn on the switch and press the OFF button to turn off the switch.
- Operate the electric mechanism to turn on and off the switch. For a cable incoming cabinet, use the electric mechanism to turn on and off the switch; for a cable outgoing cabinet, use the electric mechanism to turn on the switch but use the coil to turn off the switch.  
If a probe fuse is selected and used, the mechanism supports turn-off function. During turning on the load switch, the turn-off spring has been in Energy storage state. If the probe of the fuse hits the relief mechanism, the operation mechanism is driven to turn off the switch.

## 使用与故障处理

### Use and Trouble shooting

- 送电前检查：环网柜在送电前，应全面检查环网柜的所有元件的电气性能、绝缘水平、接线正确性及防误操作的可靠性，检查后认为完好，接通电源，观察指示仪表的工作情况，若正常，可投入运行。
- 正常运行时，负荷开关应在合闸位置，接地开关处于分闸位置，前门板处于闭合状态。
- 当环网柜或输出电缆发生故障时，应先分闸该柜内的负荷开关，此时，可打开前门板入内检修。上部主母线处于带电状态，熔断器若需更换，仍按上述操作顺序进行。

- Pre-check: before turning on the ring main unit to transmit power, check the electric properties, insulation level, wiring, and reliability of misoperation prevention of all elements. If all the elements are sound, connect a power supply to the cabinet and check the working situation of the indicators and instruments. If they are all sound, put the cabinet into operation.
- During normal running, the load-breaking switch is expected to be in the ON position, the grounding switch is in OFF position, and the front door is closed.
- In case of a fault on the ring main unit or output cable, turn off the load-breaking switch and open the front door to enter the cabinet for inspection and repair.

Note that the upper part of the main bus is energized. To replace the fuse, follow the steps to operate the cabinet.

## 维护

### Maintenance

• 环网柜在下列情况下进行检查:

- 满负荷操作 100 次后，应对负荷开关的主回路电阻及绝缘水平进行检查，并视情况可送制造厂大修；
- 无负荷操作 5000 次后，应对负荷开关的机构特性和机械操作进行检查。

- 定期检查环网柜是否有不正常情况，一经发现请及时采取措施。
- 运行人员应熟悉环网柜的所有部分，包括结构性能及安装等。

• The ring main unit needs inspection in the following situations:

- The cabinet has been operated in full load mode for more than 100 times. Check the main circuit resistance and insulation level of the the load-breaking switch and send the cabinet to the manufacturer factory for thorough repair;
- The cabinet has been operated in no load mode for more than 5000 times. Check the mechanism features and mechanical operations of the the load-breaking switch.

• Periodically check the ring main unit for anomaly. Once any anomaly is found, take measures immediately.

• The operator shall familiarize himself/herself with all parts of the ring main unit, including its structural performance and installation requirements.

## 运输、验收及贮存

### Transportation, Acceptance and Storage

- 本产品运输时，不允许有强烈震动，不允许倒置、翻滚开关。
- 开箱检查：用户在开箱前，应对环网柜的包装及运输过程中有否损伤及损坏环网柜进行检查，开箱应在干燥不受淋雨的场所进行。拆箱时注意保护产品，避免损伤，开箱后，应及时进行外观检查，检查各元件有无破损，有无进水或严重受潮现象，检查配件是否与装箱单或订单相符。
- 环网柜应存放在通风良好，并能防止各种有害气体侵入的场所，严禁与化学药品、酸碱及蓄电池等保存同一仓库里。

• Avoid violent vibration, upside down placement, and rolling the switches during transportation.

• Open the package for inspection. Before opening the package, check for any damage that may be caused during packaging and transportation. Place the cabinet in dry environment to open the package. During unpacking, make sure to protect the product from any possible damage. Check the appearance of the cabinet and various elements for damage, water leakage, and damped part and check fittings against the packing list or order for missed parts.

• Store the ring main unit in well ventilated place that can be protected against different kinds of hazardous gases. Do not store the cabinet with chemicals, drugs, and batteries in the same warehouse.

## 随机文件

### Accompanied Files

本产品必须提供下列文件:

The following materials will be accompanied with the product:

- |                    |                                                                   |
|--------------------|-------------------------------------------------------------------|
| a. 安装使用说明书;        | a.Installation and operation guide                                |
| b. 所选用的主要电器元件的说明书; | b.Guide to main electric elements                                 |
| c. 产品合格证;          | c.Product certificate                                             |
| d. 产品出厂试验记录;       | d.Factory test report                                             |
| e. 装箱单;            | e.Packing list                                                    |
| f. 环网柜排列图、二次接线图。   | f.Ring main unit arrangement diagram and secondary wiring diagram |

## 订货须知

### Notice for Order Placement

用户应向制造厂提供以下内容:

The following materials will be accompanied with the product:







- 产品名称、型号、方案号、数量及交货期限;
  - 柜内所装元器件的名称、型号规格及数量;
  - 环网柜的排列图或平面布置图;
  - 母线材料种类可由用户提出, 如无要求则按制造厂标准供给;
  - 二次回路展开图;
  - 柜体颜色, 如无要求则按制造厂标准供给。
- Product name, model, solution number, quantity and expected delivery time;
  - Names of elements of the ring main unit, model & specifications, and quantity;
  - Arrangement diagram of the ring main units and floor plan;
  - Types of materials of the main bus may be provided by users or supplied by the manufacturer in accordance with its standards if the users do not raise any requirement;
  - Secondary circuit diagram;
  - Cabinet color, if no requirement is made, the manufacturer will supply cabinets in accordance with its standards.



## 一次方案

### Primary Solution

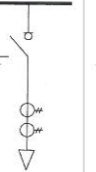
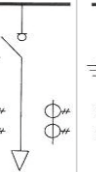
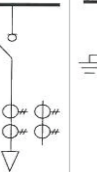
环网柜的一次方案见下表。

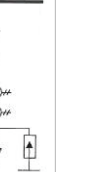
The following tables show the primary solution for ring main units.

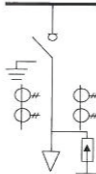
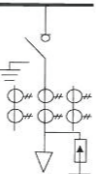
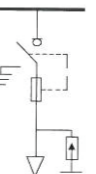
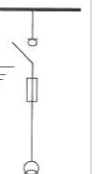
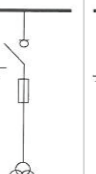
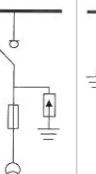
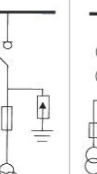
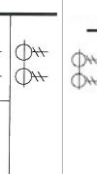
方案编号 Solution Number	1	2	3	4	5	6	7	8	9	
一次结构方案 Primary wiring solution										
柜宽 (mm) Cabinet width	375	500	500	500	500	500	500	500	500	
主要电 器元件 Main electric elements	型号 Model	数量 Qty.								
	SFL-12		1	1	1	1	1	1	1	1
	SFLAJ-12				3					
	RN2-12									
	LZZBJ6					1	2	3		1
	JDZ-10									
	HY5W-17								3	3

方案编号 Solution Number	10	11	12	13	14	15	16	17	18	
一次结构方案 Primary wiring solution										
柜宽 (mm) Cabinet width	500	500	500	500	500	500	500	700	700	
主要电 器元件 Main electric elements	型号 Model	数量 Qty.								
	SFL-12	1	1	1	1	1	1	1		
	SFLAJ-12			3						
	RN2-12				3	3	3	3	3	3
	LZZBJ6	2	3						2	2
	JDZ-10				2	3	2	2	2	2
	HY5W-17	3	3	3				3	3	

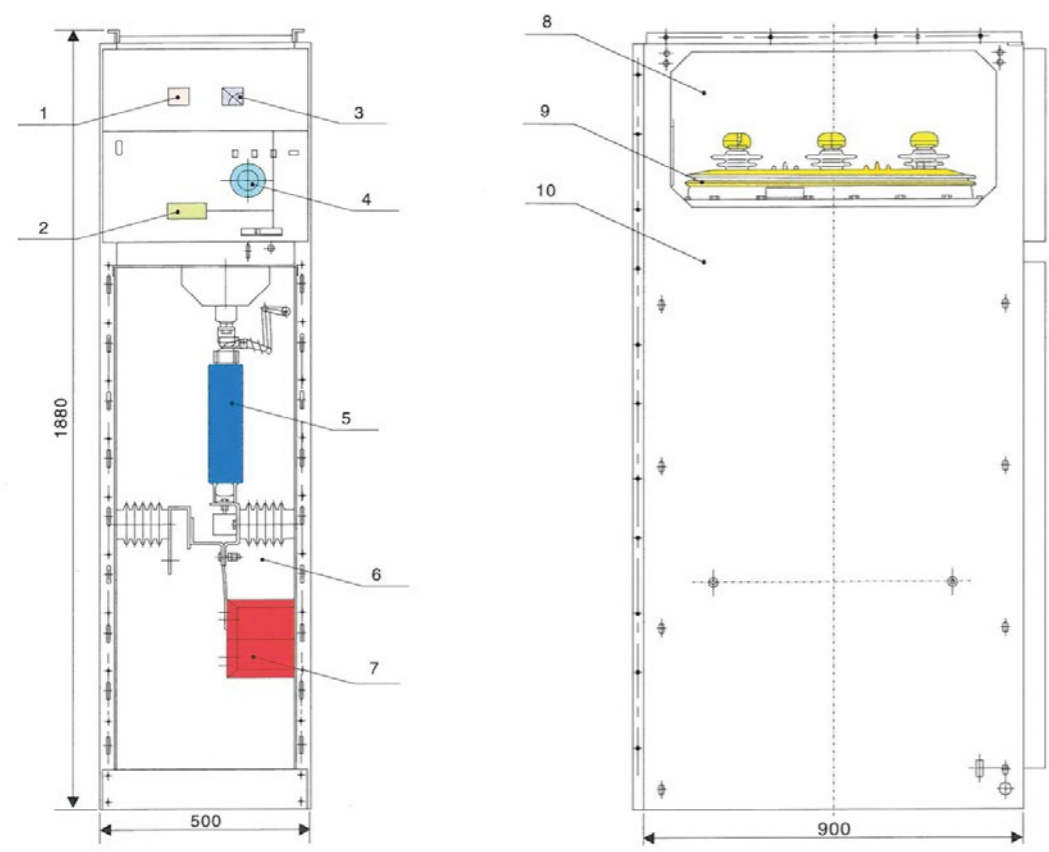

基本结构示意图  
Figure 1 Basic structural diagram

- |          |             |                            |                        |
|----------|-------------|----------------------------|------------------------|
| 1. 凝露控制器 | 6. 电缆室      | 1. Condensation controller | 6. Cable cubicle       |
| 2. 带电显示器 | 7. 电流互感器    | 2. Energized display       | 7. Current transformer |
| 3. 电流表   | 8. 母线室      | 3. Ammeter                 | 8. Bus cubicle         |
| 4. 操作机构  | 9. SFL 负荷开关 | 4. Operation mechanism     | 9. SFL load switch     |
| 5. 熔断器   | 10. 框架      | 5. Fuse                    | 10. Frame              |

方案编号 Solution Number	01#	02#~16#	17#~18#
L	375	500	700
L1	325	450	650

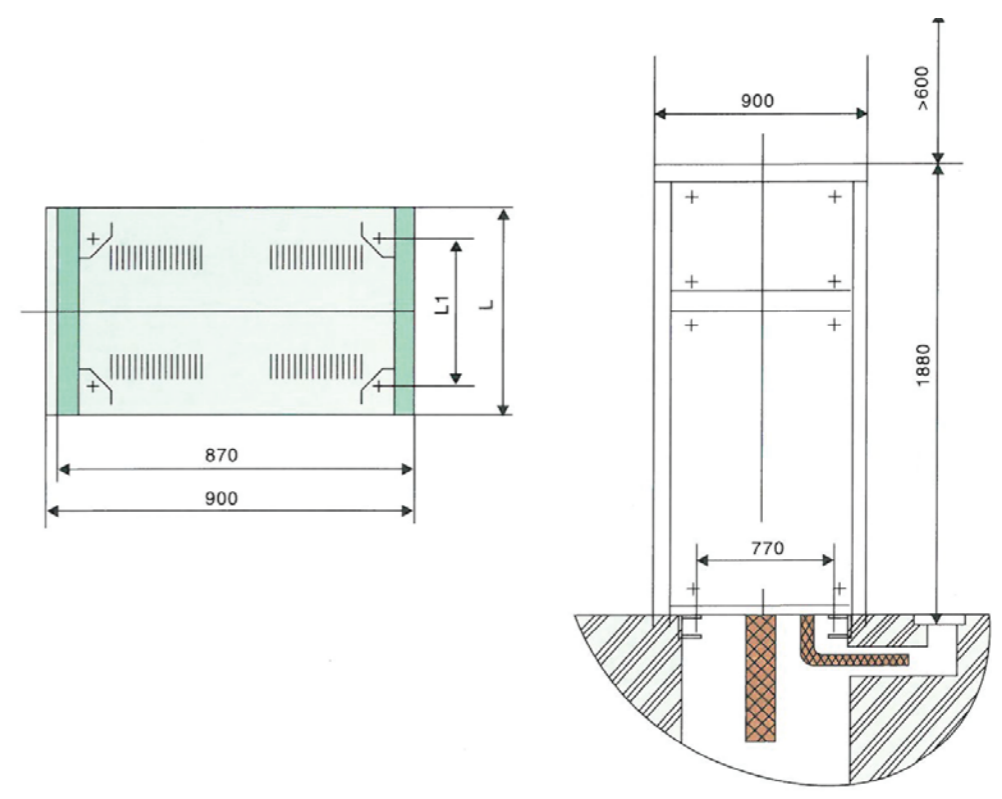

图 2 开关柜外形尺寸、安装尺寸及电缆进出线的布置示意图  
Figure 2 Appearance dimensions, installation dimensions, and cable incoming/outgoing deployment of switchgear

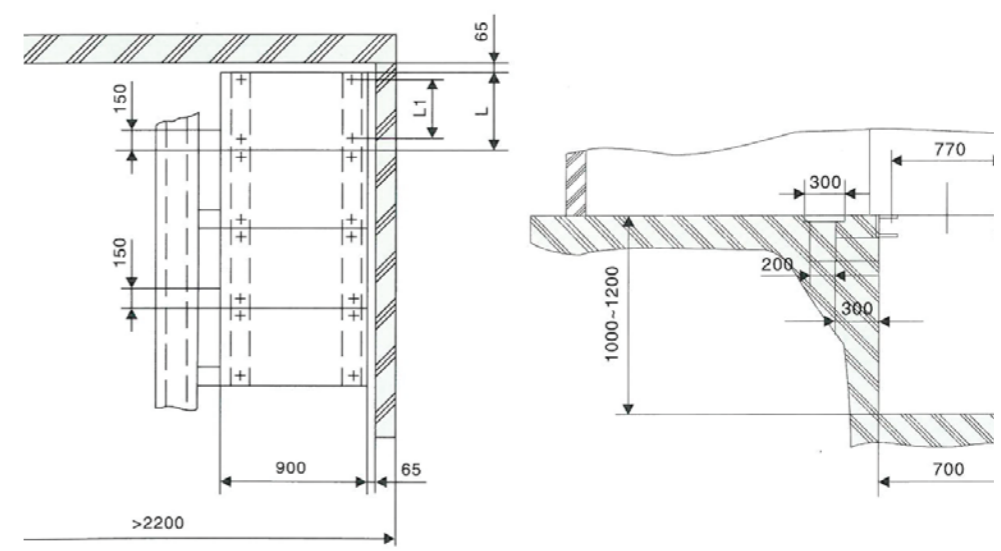

图 3 开关柜安装基础典型示例  
Figure 3 Typical example of switchgear installation foundation